

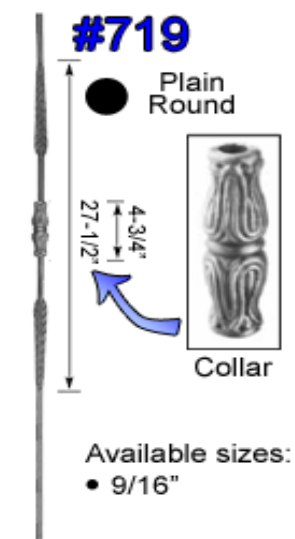

Baluster Options

! "#\$%&'()*+(-./&%-\$#(0&1"-2(,)*2\$*%-)+*,)&%3)*+*)-2&\$,-4)5+)3*")6*)%*2)-((78&2)3*")&(,)1**9\$%) +*,)\$%)&0&1"-2(,7():&%)/,*#\$6()&66\$2\$*%&1)*2\$*%-)*,)\$%:* ,/*,&2();*-2)&%3)0&1"-2(,)\$%2*)3*"),"-2*,-2&\$,<

<p>#700</p> <p>● Plain Round</p> <p>Duvirage Quality Standard</p> <p>Available size: • 3/4"</p>	<p>#701</p> <p>■ Plain Square</p> <p>Available sizes: • 9/16" • 5/8"</p>	<p>#702</p> <p>■ Plain Square</p> <p>9-3/4"</p> <p>Available sizes: • 9/16" • 5/8"</p>	<p>#703</p> <p>■ Plain Square</p> <p>24" 6-5/16"</p> <p>Available sizes: • 9/16" • 5/8"</p>
<p>#704</p> <p>■ Plain Square</p> <p>23-5/8" 5-1/2"</p> <p>Teutonic Collar</p> <p>Available sizes: • 9/16" • 5/8"</p>	<p>#705</p> <p>■ Plain Square</p> <p>22-3/4"</p> <p>Available size: • 9/16" • 5/8"</p>	<p>#706</p> <p>■ Plain Square</p> <p>24" 5-7/8" 6-1/2"</p> <p>Teutonic Collar</p> <p>Available sizes: • 9/16"</p>	<p>#707</p> <p>■ Plain Square</p> <p>22-7/16"</p> <p>Available sizes: • 9/16"</p>

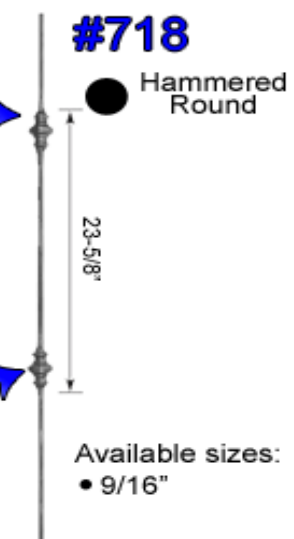
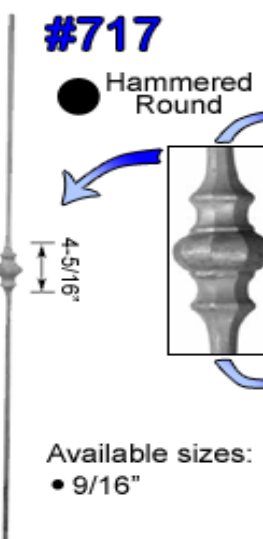
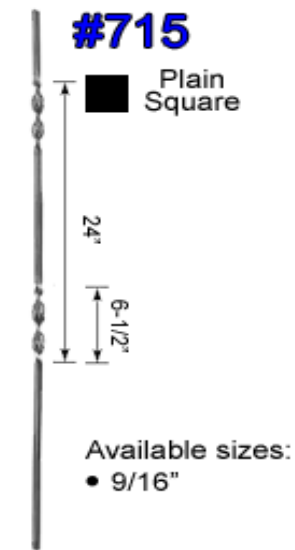
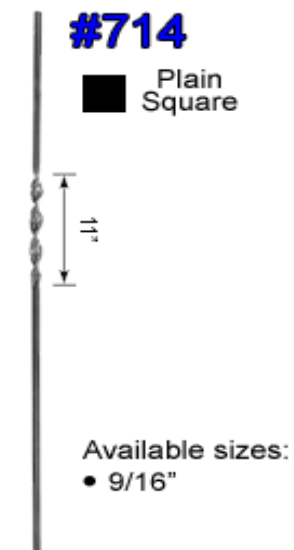
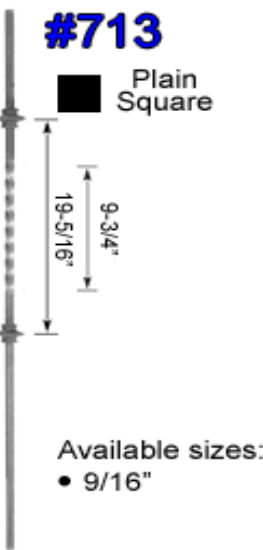
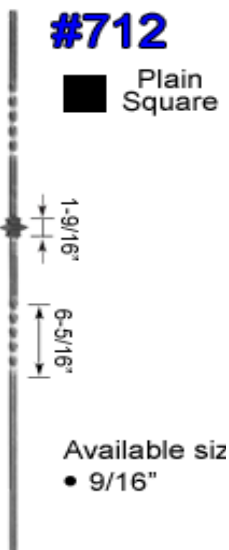
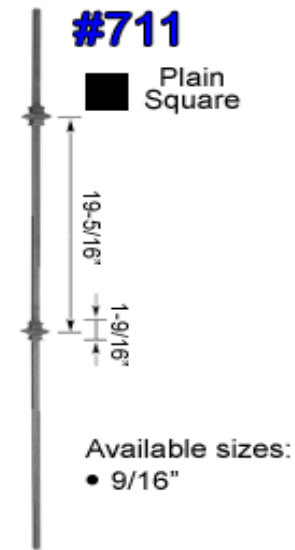
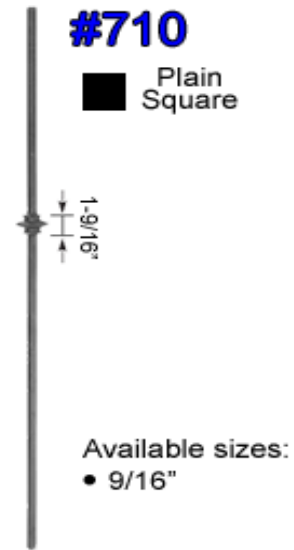
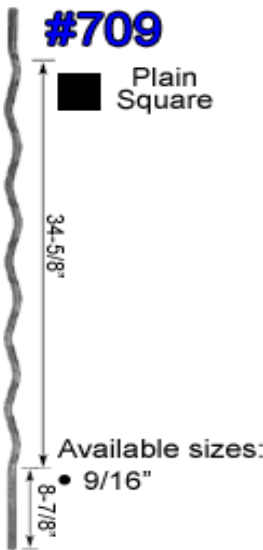
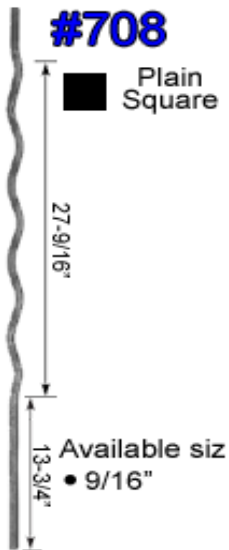

#720
 Plain Round

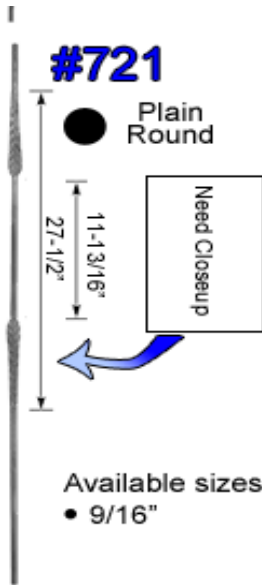
 Available size:
 • 9/16"

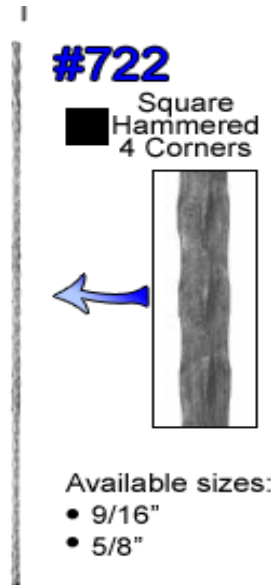
#721
 Plain Round

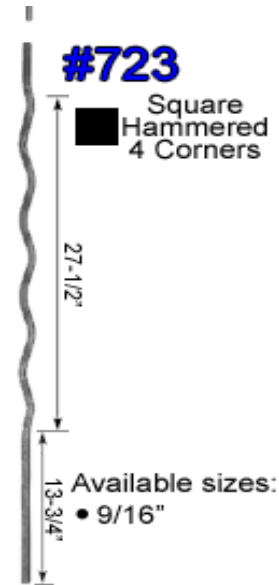
 Available sizes:
 • 9/16"

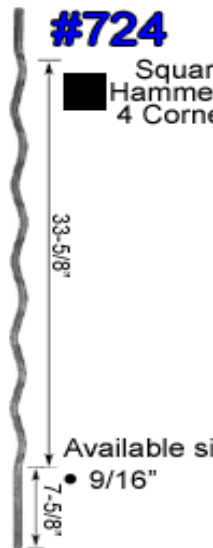
#722
 Square Hammered 4 Corners

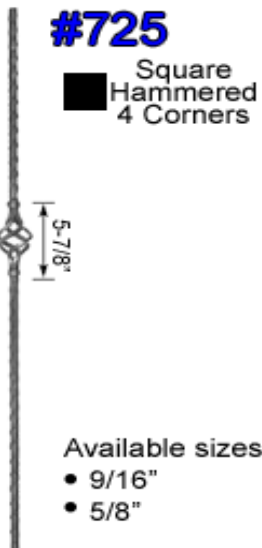
 Available sizes:
 • 9/16"
 • 5/8"

#723
 Square Hammered 4 Corners

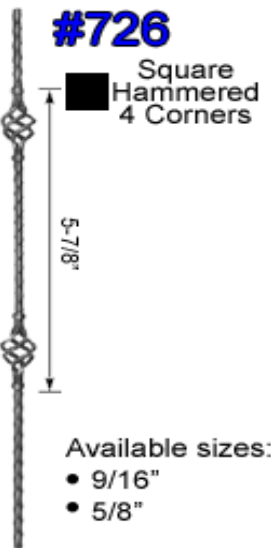
 Available sizes:
 • 9/16"

#724
 Square Hammered 4 Corners

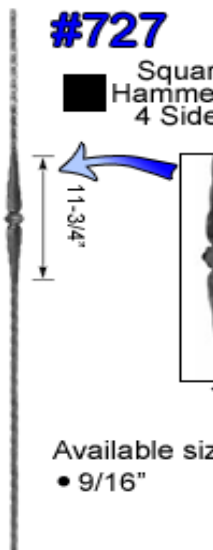
 Available size:
 • 9/16"

#725
 Square Hammered 4 Corners

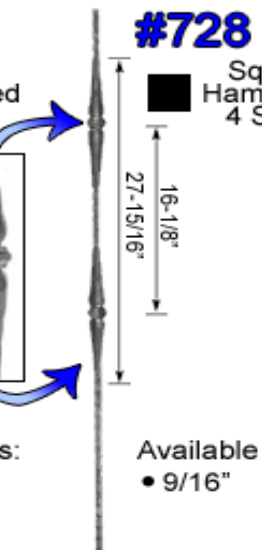
 Available sizes:
 • 9/16"
 • 5/8"

#726
 Square Hammered 4 Corners

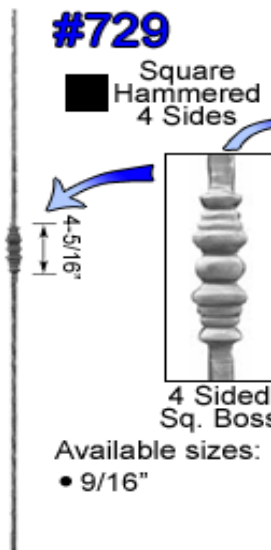
 Available sizes:
 • 9/16"
 • 5/8"

#727
 Square Hammered 4 Sides

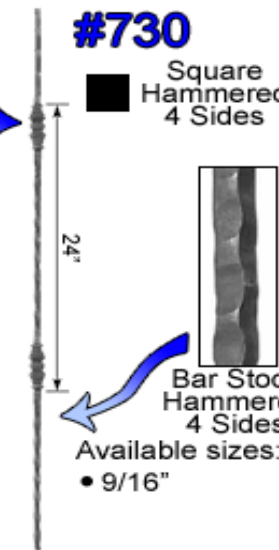
 Available sizes:
 • 9/16"

#728
 Square Hammered 4 Sides

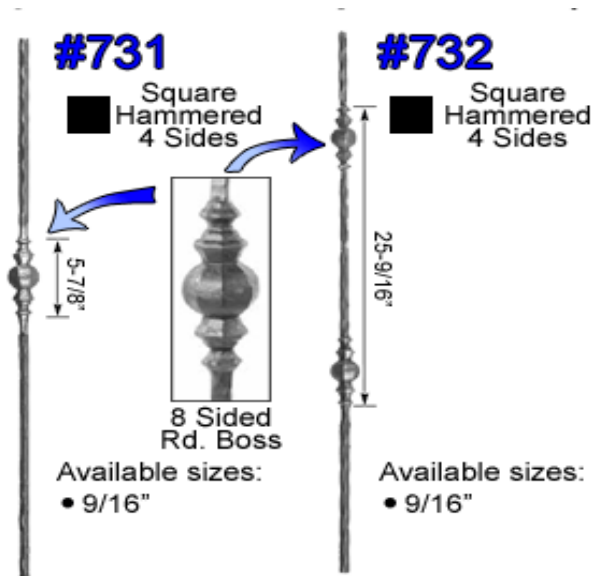
 Available size:
 • 9/16"

#729
 Square Hammered 4 Sides

 Available sizes:
 • 9/16"

#730
 Square Hammered 4 Sides

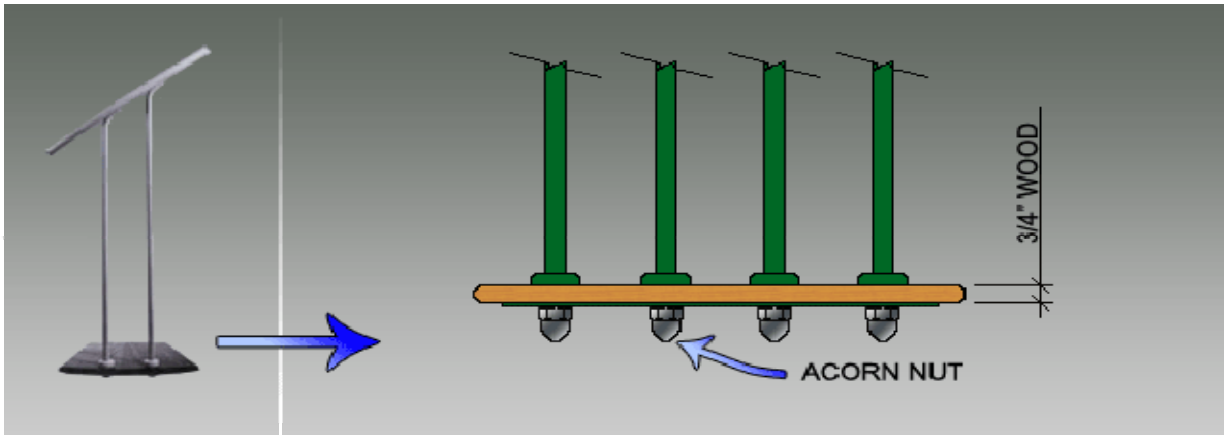
 Available sizes:
 • 9/16"



Standard Baluster Attachments

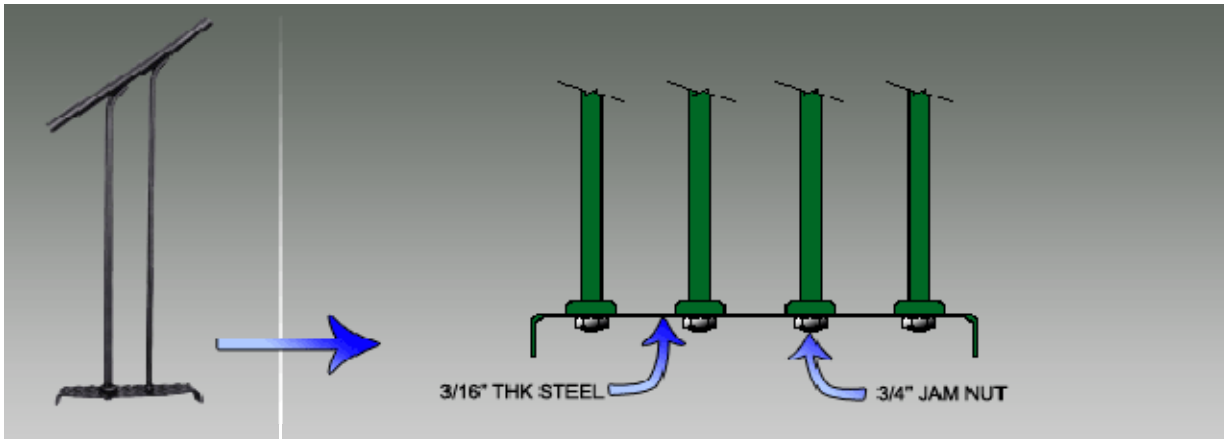

Baluster attachment on a No. 141 Tread Design



Baluster attachment on a No. 111, No. 131, No. 135, No. 175 Tread Designs

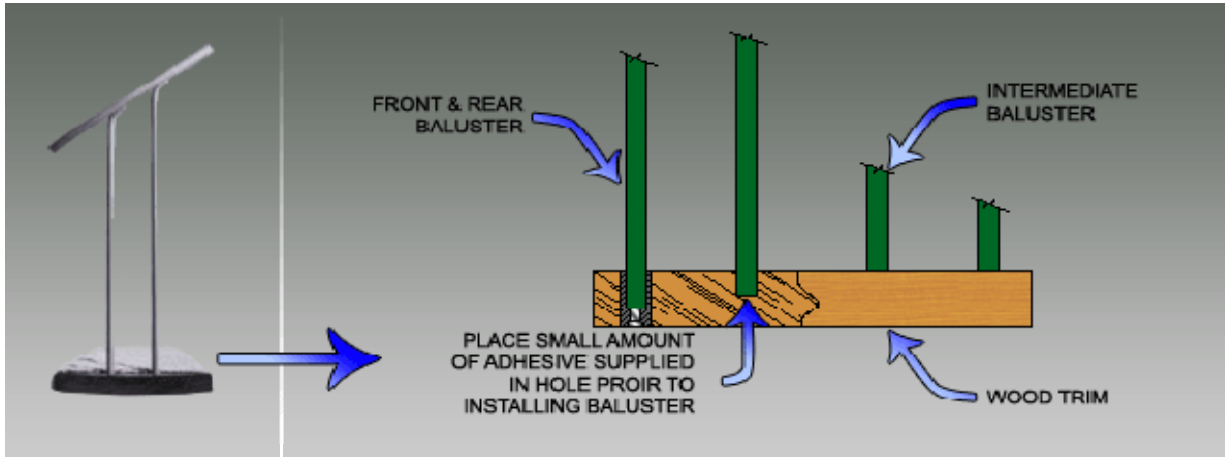

Baluster attachment on a No. 165 Tread Design

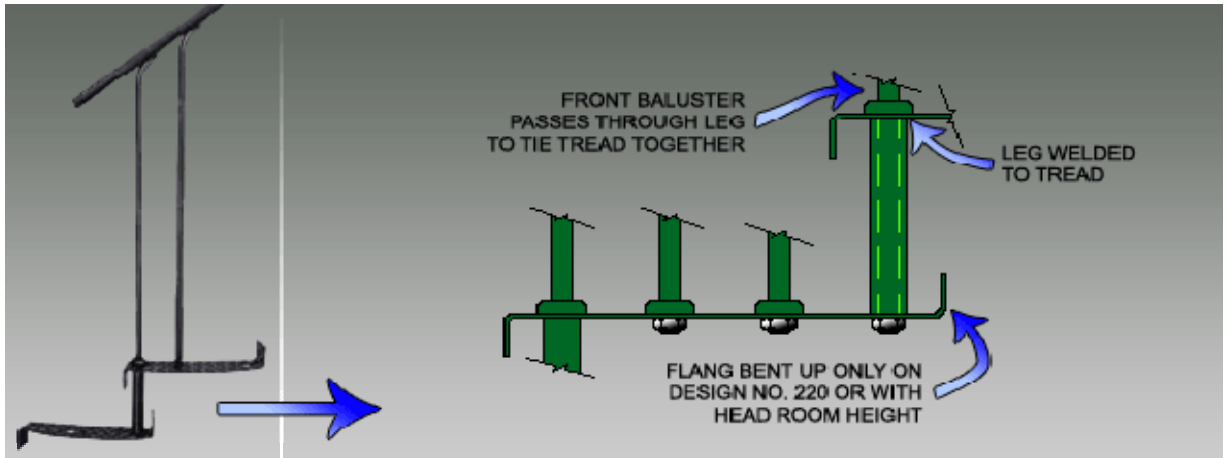

Baluster attachment on a No. 201, No. 220, No. 251, and No. 320 Tread Designs